

Информационен лист | Номер на артикул: 857-304

Relay module; Nominal input voltage: 24 VDC; 1 changeover contact;
Limiting continuous current: 6 A; Yellow status indicator; Module width: 6 mm; 2,50 mm²; gray

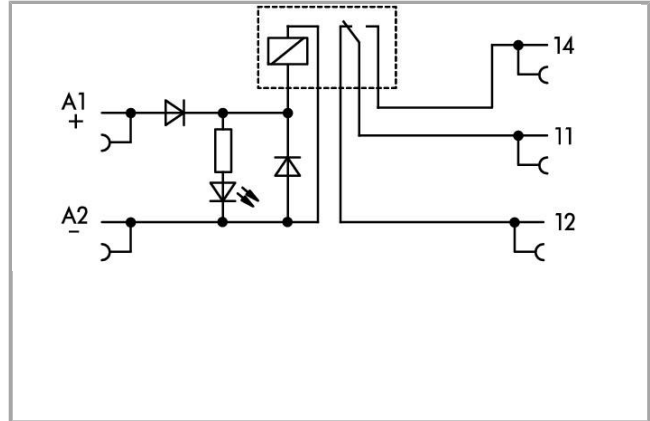

www.wago.com/857-304

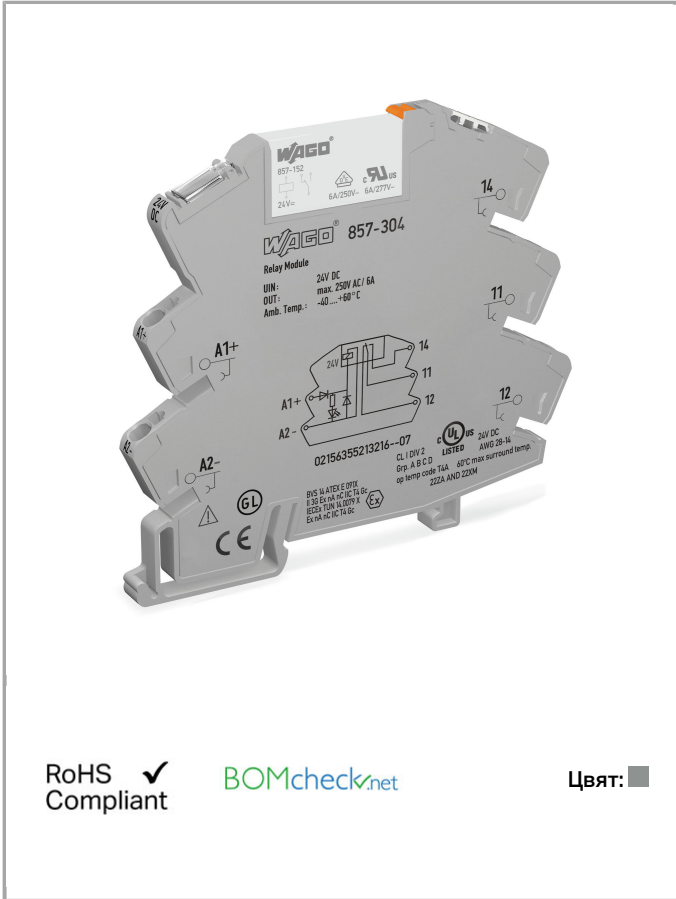

RoHS Compliant ✓

BOMcheck.net

Цвят: ■

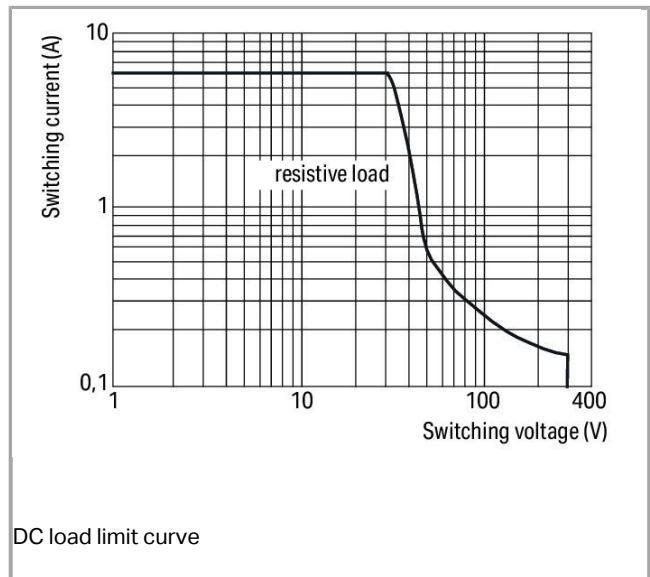
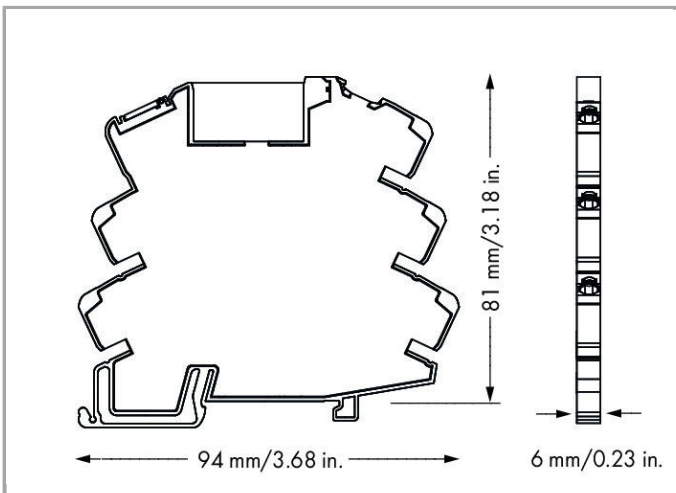

DC load limit curve

Описание на артикула

Note:

Inductive loads have to be attenuated by an appropriate protective circuit in order to protect relay coils and contacts.

Данни

Technical Data

Control circuit

Nominal input voltage U_N	DC 24 V
Input voltage range	-15 ... +20 %
Nominal input current at U_N	10 mA

Load circuit:

Number of changeover/switchover contacts	1
Contact material (relay)	AgSnO ₂
Limiting continuous current	6 A
Max. make current (resistive)	(AC) 20 A / 0.02 s
Max. switching voltage	AC 250 V
Max. switching power (resistive)	AC 1500 VA; DC see load limit curve
Switching capacity	AC-15: 3 A / AC 250 V; DC-13: 2 A / DC 24 V
Recommended minimum load	10 V / 10 mA; 24 V / 1 mA
Pull-in time (typ.)	8 ms
Drop-out time (typ.)	8 ms
Bounce time (typ.)	3.5 ms
Electrical life (N.O.; resistive load; 23 °C)	50 x 10 ³ switching operations
Mechanical life	5 x 10 ⁶ switching operations
Max. switching load with load/without load	6 min ⁻¹ / 180 min ⁻¹

Signaling

Status indication	LED yellow
-------------------	------------

Safety and protection:

Rated voltage	250 V
Rated impulse voltage	4 kV
Pollution degree	2
Dielectric strength, control/load circuit (AC, 1 min)	4 kVrms

Dielectric strength open contact (AC, 1 min)	1 kVrms
Protection class	IP20

Connection data

Connection technology	Push-in CAGE CLAMP®
Solid conductor	0.34 ... 2.5 mm ² / 22 ... 14 AWG
Fine-stranded conductor	0.34 ... 2.5 mm ² / 22 ... 14 AWG
Strip length	9 ... 10 mm / 0.35 ... 0.39 inch

Geometrical Data

Width	6 mm / 0.236 inch
Height from upper-edge of DIN-35 rail	81 mm / 3.189 inch
Depth	94 mm / 3.701 inch

Mechanical data

Type of mounting	DIN-35 rail
------------------	-------------

Material Data

Color	gray
Weight	31.56 g

Environmental Requirements

Pollution degree	2
Surrounding air (operating) temperature at U _N	-40 ... 60 °C
Surrounding air (storage) temperature	-40 ... 70 °C
Processing temperature	-25 ... +50 °C

Standards and specifications

Standards/specifications	EN 61010-2-201; EN 61810-1; EN 61373; UL 508; GL, ATEX, IEC Ex
--------------------------	--

Elementary relay



WAGO elementary relay	857-152
-----------------------	---------

Commercial data



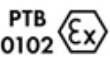

Product Group	6 (Interface Electronics)
Country of origin	CN
GTIN	4050821797807
Customs Tariff No.	85364900990

Одобрения / Сертификати

Ex-Approvals

Лого	Одобрение	Допълнителен текст за одобрение	Име на сертификат
	ATEX DEKRA EXAM GmbH	EN 60079-0	BVS_14_ATEX_E_091_X
	IECEX DEKRA EXAM GmbH	IEC 60079-0	IECEX_BVS_14.0079_X
	UL UL International Germany GmbH (HAZARDOUS LOCATIONS)	ANSI/ISA 12.12.01	E198726 Sec.4

Ship Approvals

Лого	Одобрение	Допълнителен текст за одобрение	Име на сертификат
	BV Bureau Veritas S.A.	-	40179_A0
	DNV GL Det Norske Veritas, Germanischer Lloyd	-	TAA00001D1
	NK Nippon Kaiji Kyokai	-	TA17255M
	PRS Polski Rejestr Statków	-	TE/2186 /880590/18

UL-Approvals

Лого	Одобрение	Допълнителен текст за одобрение	Име на сертификат
	UL UL International Netherlands B.V. (ORDINARY LOCATIONS)	UL 508	E175199 Sec.4

Съвместими продукти

tools

**Артикул №: 210-720**

Operating tool; Blade: 3.5 x 0.5 mm; with a partially insulated shaft

www.wago.com/210-720

Jumper

**Артикул №: 281-482**

Comb-style jumper bar; insulated; 2-way; IN = IN terminal block; gray

www.wago.com/281-482**Артикул №: 859-402**

Push-in type jumper bar; 2-way; Nominal current 18 A; insulated; light gray

www.wago.com/859-402**Артикул №: 859-402/000-005**

Push-in type jumper bar; 2-way; Nominal current 18 A; insulated; red

www.wago.com/859-402/000-005**Артикул №: 859-402/000-006**

Push-in type jumper bar; 2-way; Nominal current 18 A; insulated; blue

www.wago.com/859-402/000-006**Артикул №: 859-402/000-029**

Push-in type jumper bar; 2-way; Nominal current 18 A; insulated; yellow

www.wago.com/859-402/000-029**Артикул №: 859-403**

Push-in type jumper bar; 3-way; Nominal current 18 A; insulated; light gray

www.wago.com/859-403**Артикул №: 859-403/000-005**

Push-in type jumper bar; 3-way; Nominal current 18 A; insulated; red

www.wago.com/859-403/000-005**Артикул №: 859-403/000-006**

Push-in type jumper bar; 3-way; Nominal current 18 A; insulated; blue

www.wago.com/859-403/000-006**Артикул №: 859-403/000-029**

Push-in type jumper bar; 3-way; Nominal current 18 A; insulated; yellow

www.wago.com/859-403/000-029**Артикул №: 859-404**

Push-in type jumper bar; 4-way; Nominal current 18 A; insulated; light gray

www.wago.com/859-404**Артикул №: 859-404/000-005**













Push-in type jumper bar; 4-way; Nominal current 18 A; insulated; red

www.wago.com/859-404/000-005**Артикул №: 859-404/000-006**

Push-in type jumper bar; 4-way; Nominal current 18 A; insulated; blue



www.wago.com/859-404/000-006

	Артикул №: 859-404/000-029 Push-in type jumper bar; 4-way; Nominal current 18 A; insulated; yellow	www.wago.com/859-404/000-029
	Артикул №: 859-405 Push-in type jumper bar; 5-way; Nominal current 18 A; insulated; light gray	www.wago.com/859-405
	Артикул №: 859-405/000-005 Push-in type jumper bar; 5-way; Nominal current 18 A; insulated; red	www.wago.com/859-405/000-005
	Артикул №: 859-405/000-006 Push-in type jumper bar; 5-way; Nominal current 18 A; insulated; blue	www.wago.com/859-405/000-006
	Артикул №: 859-405/000-029 Push-in type jumper bar; 5-way; Nominal current 18 A; insulated; yellow	www.wago.com/859-405/000-029
	Артикул №: 859-406 Push-in type jumper bar; 6-way; Nominal current 18 A; insulated; light gray	www.wago.com/859-406
	Артикул №: 859-406/000-005 Push-in type jumper bar; 6-way; Nominal current 18 A; insulated; red	www.wago.com/859-406/000-005
	Артикул №: 859-406/000-006 Push-in type jumper bar; 6-way; Nominal current 18 A; insulated; blue	www.wago.com/859-406/000-006
	Артикул №: 859-406/000-029 Push-in type jumper bar; 6-way; Nominal current 18 A; insulated; yellow	www.wago.com/859-406/000-029
	Артикул №: 859-407 Push-in type jumper bar; 7-way; Nominal current 18 A; insulated; light gray	www.wago.com/859-407
	Артикул №: 859-407/000-005 Push-in type jumper bar; 7-way; Nominal current 18 A; insulated; red	www.wago.com/859-407/000-005
	Артикул №: 859-407/000-006 Push-in type jumper bar; 7-way; Nominal current 18 A; insulated; blue	www.wago.com/859-407/000-006
	Артикул №: 859-407/000-029 Push-in type jumper bar; 7-way; Nominal current 18 A; insulated; yellow	www.wago.com/859-407/000-029
	Артикул №: 859-408 Push-in type jumper bar; 8-way; Nominal current 18 A; insulated; light gray	www.wago.com/859-408
	Артикул №: 859-408/000-005 Push-in type jumper bar; 8-way; Nominal current 18 A; insulated; red	www.wago.com/859-408/000-005
	Артикул №: 859-408/000-006 Push-in type jumper bar; 8-way; Nominal current 18 A; insulated; blue	www.wago.com/859-408/000-006













	Артикул №: 859-408/000-029 Push-in type jumper bar; 8-way; Nominal current 18 A; insulated; yellow	www.wago.com/859-408/000-029
	Артикул №: 859-409 Push-in type jumper bar; 9-way; Nominal current 18 A; insulated; light gray	www.wago.com/859-409
	Артикул №: 859-409/000-005 Push-in type jumper bar; 9-way; Nominal current 18 A; insulated; red	www.wago.com/859-409/000-005
	Артикул №: 859-409/000-006 Push-in type jumper bar; 9-way; Nominal current 18 A; insulated; blue	www.wago.com/859-409/000-006
	Артикул №: 859-409/000-029 Push-in type jumper bar; 9-way; Nominal current 18 A; insulated; yellow	www.wago.com/859-409/000-029
	Артикул №: 859-410 Push-in type jumper bar; 10-way; Nominal current 18 A; insulated; light gray	www.wago.com/859-410
	Артикул №: 859-410/000-005 Push-in type jumper bar; 10-way; Nominal current 18 A; insulated; red	www.wago.com/859-410/000-005
	Артикул №: 859-410/000-006 Push-in type jumper bar; 10-way; Nominal current 18 A; insulated; blue	www.wago.com/859-410/000-006
	Артикул №: 859-410/000-029 Push-in type jumper bar; 10-way; Nominal current 18 A; insulated; yellow	www.wago.com/859-410/000-029
ferrule		
	Артикул №: 216-241 Ferrule; Sleeve for 0.5 mm ² / 20 AWG; insulated; electro-tin plated; electrolytic copper; gastight crimped; acc. to DIN 46228, Part 4/09.90; white	www.wago.com/216-241
	Артикул №: 216-242 Ferrule; Sleeve for 0.75 mm ² / 18 AWG; insulated; electro-tin plated; electrolytic copper; gastight crimped; acc. to DIN 46228, Part 4/09.90; gray	www.wago.com/216-242
	Артикул №: 216-243 Ferrule; Sleeve for 1 mm ² / AWG 18; insulated; electro-tin plated; electrolytic copper; gastight crimped; acc. to DIN 46228, Part 4/09.90; red	www.wago.com/216-243
	Артикул №: 216-244 Ferrule; Sleeve for 1.5 mm ² / AWG 16; insulated; electro-tin plated; electrolytic copper; gastight crimped; acc. to DIN 46228, Part 4/09.90; black	www.wago.com/216-244
General accessories		
	Артикул №: 209-184 Protection cover; transparent	www.wago.com/209-184
	Артикул №: 249-105 Group marker carrier	www.wago.com/249-105
	Артикул №: 857-152 Basic relay; Nominal input voltage: 24 VDC; 1 changeover contact; Limiting continuous current: 6 A;	www.wago.com/857-152















Module width: 5 mm; Module height: 15 mm















transfer module















	Артикул №: 857-981 Interface adapter; 14-pole; High-side switching input	www.wago.com/857-981
	Артикул №: 857-982 Interface adapter; 14-pole; High-side switching output	www.wago.com/857-982
	Артикул №: 857-986 Interface adapter; 15-pole; High-side switching input	www.wago.com/857-986

Marking accessories

	Артикул №: 2009-110 Marking strips; on reel; not stretchable; plain; snap-on type; white	www.wago.com/2009-110
	Артикул №: 2009-115 WMB-Inline; for Smart Printer; on reel; stretchable 5 - 5.2 mm; plain; snap-on type; white	www.wago.com/2009-115
	Артикул №: 2009-115/000-002 WMB-Inline; for Smart Printer; on reel; stretchable 5 - 5.2 mm; plain; snap-on type; yellow	www.wago.com/2009-115/000-002
	Артикул №: 2009-115/000-006 WMB-Inline; for Smart Printer; on reel; stretchable 5 - 5.2 mm; plain; snap-on type; blue	www.wago.com/2009-115/000-006
	Артикул №: 2009-115/000-007 WMB-Inline; for Smart Printer; on reel; stretchable 5 - 5.2 mm; plain; snap-on type; gray	www.wago.com/2009-115/000-007
	Артикул №: 2009-115/000-012 WMB-Inline; for Smart Printer; on reel; stretchable 5 - 5.2 mm; plain; snap-on type; orange	www.wago.com/2009-115/000-012
	Артикул №: 2009-115/000-017 WMB-Inline; for Smart Printer; on reel; stretchable 5 - 5.2 mm; plain; snap-on type; light green	www.wago.com/2009-115/000-017
	Артикул №: 2009-115/000-023 WMB-Inline; for Smart Printer; on reel; stretchable 5 - 5.2 mm; plain; snap-on type; green	www.wago.com/2009-115/000-023
	Артикул №: 2009-115/000-024 WMB-Inline; for Smart Printer; on reel; stretchable 5 - 5.2 mm; plain; snap-on type; violet	www.wago.com/2009-115/000-024
	Артикул №: 209-128 Adaptor	www.wago.com/209-128
	Артикул №: 209-183 Marker card; white	www.wago.com/209-183
	Артикул №: 210-110 Fiber-tip pen	www.wago.com/210-110

	Артикул №: 793-501 WMB marking card; as card; not stretchable; plain; snap-on type; white	www.wago.com/793-501
	Артикул №: 793-501/000-002 WMB marking card; as card; not stretchable; plain; snap-on type; white	www.wago.com/793-501/000-002
	Артикул №: 793-501/000-005 WMB marking card; as card; not stretchable; plain; snap-on type; white	www.wago.com/793-501/000-005
	Артикул №: 793-501/000-006 WMB marking card; as card; not stretchable; plain; snap-on type; white	www.wago.com/793-501/000-006
	Артикул №: 793-501/000-007 WMB marking card; as card; not stretchable; plain; snap-on type; white	www.wago.com/793-501/000-007
	Артикул №: 793-501/000-012 WMB marking card; as card; not stretchable; plain; snap-on type; white	www.wago.com/793-501/000-012
	Артикул №: 793-501/000-017 WMB marking card; as card; not stretchable; plain; snap-on type; white	www.wago.com/793-501/000-017
	Артикул №: 793-501/000-023 WMB marking card; as card; not stretchable; plain; snap-on type; white	www.wago.com/793-501/000-023
	Артикул №: 793-501/000-024 WMB marking card; as card; not stretchable; plain; snap-on type; white	www.wago.com/793-501/000-024
	Артикул №: 793-502 WMB marking card; as card; MARKED; 1 ... 10 (10x); not stretchable; Horizontal marking; snap-on type; white	www.wago.com/793-502
	Артикул №: 793-502/000-002 WMB marking card; as card; MARKED; 1 ... 10 (10x); not stretchable; Horizontal marking; snap-on type; white	www.wago.com/793-502/000-002
	Артикул №: 793-502/000-005 WMB marking card; as card; MARKED; 1 ... 10 (10x); not stretchable; Horizontal marking; snap-on type; white	www.wago.com/793-502/000-005
	Артикул №: 793-502/000-006 WMB marking card; as card; MARKED; 1 ... 10 (10x); not stretchable; Horizontal marking; snap-on type; white	www.wago.com/793-502/000-006
	Артикул №: 793-502/000-007 WMB marking card; as card; MARKED; 1 ... 10 (10x); not stretchable; Horizontal marking; snap-on type; white	www.wago.com/793-502/000-007
	Артикул №: 793-502/000-012 WMB marking card; as card; MARKED; 1 ... 10 (10x); not stretchable; Horizontal marking; snap-on type; white	www.wago.com/793-502/000-012

	Артикул №: 793-502/000-017 WMB marking card; as card; MARKED; 1 ... 10 (10x); not stretchable; Horizontal marking; snap-on type; white	www.wago.com/793-502/000-017
	Артикул №: 793-502/000-023 WMB marking card; as card; MARKED; 1 ... 10 (10x); not stretchable; Horizontal marking; snap-on type; white	www.wago.com/793-502/000-023
	Артикул №: 793-502/000-024 WMB marking card; as card; MARKED; 1 ... 10 (10x); not stretchable; Horizontal marking; snap-on type; white	www.wago.com/793-502/000-024
	Артикул №: 793-503 WMB marking card; as card; MARKED; 11 ... 20 (10x); not stretchable; Horizontal marking; snap-on type; white	www.wago.com/793-503
	Артикул №: 793-503/000-002 WMB marking card; as card; MARKED; 11 ... 20 (10x); not stretchable; Horizontal marking; snap-on type; white	www.wago.com/793-503/000-002
	Артикул №: 793-503/000-005 WMB marking card; as card; MARKED; 11 ... 20 (10x); not stretchable; Horizontal marking; snap-on type; white	www.wago.com/793-503/000-005
	Артикул №: 793-503/000-006 WMB marking card; as card; MARKED; 11 ... 20 (10x); not stretchable; Horizontal marking; snap-on type; white	www.wago.com/793-503/000-006
	Артикул №: 793-503/000-007 WMB marking card; as card; MARKED; 11 ... 20 (10x); not stretchable; Horizontal marking; snap-on type; white	www.wago.com/793-503/000-007
	Артикул №: 793-503/000-012 WMB marking card; as card; MARKED; 11 ... 20 (10x); not stretchable; Horizontal marking; snap-on type; white	www.wago.com/793-503/000-012
	Артикул №: 793-503/000-017 WMB marking card; as card; MARKED; 11 ... 20 (10x); not stretchable; Horizontal marking; snap-on type; white	www.wago.com/793-503/000-017
	Артикул №: 793-503/000-023 WMB marking card; as card; MARKED; 11 ... 20 (10x); not stretchable; Horizontal marking; snap-on type; white	www.wago.com/793-503/000-023
	Артикул №: 793-503/000-024 WMB marking card; as card; MARKED; 11 ... 20 (10x); not stretchable; Horizontal marking; snap-on type; white	www.wago.com/793-503/000-024
	Артикул №: 793-504 WMB marking card; as card; MARKED; 21 ... 30 (10x); not stretchable; Horizontal marking; snap-on type; white	www.wago.com/793-504
	Артикул №: 793-504/000-002 WMB marking card; as card; MARKED; 21 ... 30 (10x); not stretchable; Horizontal marking; snap-on type; white	www.wago.com/793-504/000-002
	Артикул №: 793-504/000-005 WMB marking card; as card; MARKED; 21 ... 30 (10x); not stretchable; Horizontal marking; snap-on type; white	www.wago.com/793-504/000-005

	Артикул №: 793-504/000-006 WMB marking card; as card; MARKED; 21 ... 30 (10x); not stretchable; Horizontal marking; snap-on type; white	www.wago.com/793-504/000-006
	Артикул №: 793-504/000-012 WMB marking card; as card; MARKED; 21 ... 30 (10x); not stretchable; Horizontal marking; snap-on type; white	www.wago.com/793-504/000-012
	Артикул №: 793-504/000-017 WMB marking card; as card; MARKED; 21 ... 30 (10x); not stretchable; Horizontal marking; snap-on type; white	www.wago.com/793-504/000-017
	Артикул №: 793-504/000-023 WMB marking card; as card; MARKED; 21 ... 30 (10x); not stretchable; Horizontal marking; snap-on type; white	www.wago.com/793-504/000-023
	Артикул №: 793-505 WMB marking card; as card; MARKED; 31 ... 40 (10x); not stretchable; Horizontal marking; snap-on type; white	www.wago.com/793-505
	Артикул №: 793-505/000-005 WMB marking card; as card; MARKED; 31 ... 40 (10x); not stretchable; Horizontal marking; snap-on type; white	www.wago.com/793-505/000-005
	Артикул №: 793-505/000-006 WMB marking card; as card; MARKED; 31 ... 40 (10x); not stretchable; Horizontal marking; snap-on type; white	www.wago.com/793-505/000-006
	Артикул №: 793-505/000-007 WMB marking card; as card; MARKED; 31 ... 40 (10x); not stretchable; Horizontal marking; snap-on type; white	www.wago.com/793-505/000-007
	Артикул №: 793-505/000-012 WMB marking card; as card; MARKED; 31 ... 40 (10x); not stretchable; Horizontal marking; snap-on type; white	www.wago.com/793-505/000-012
	Артикул №: 793-506 WMB marking card; as card; MARKED; 41 ... 50 (10x); not stretchable; Horizontal marking; snap-on type; white	www.wago.com/793-506
	Артикул №: 793-506/000-005 WMB marking card; as card; MARKED; 41 ... 50 (10x); not stretchable; Horizontal marking; snap-on type; white	www.wago.com/793-506/000-005
	Артикул №: 793-506/000-006 WMB marking card; as card; MARKED; 41 ... 50 (10x); not stretchable; Horizontal marking; snap-on type; white	www.wago.com/793-506/000-006
	Артикул №: 793-506/000-012 WMB marking card; as card; MARKED; 41 ... 50 (10x); not stretchable; Horizontal marking; snap-on type; white	www.wago.com/793-506/000-012
	Артикул №: 793-506/000-017 WMB marking card; as card; MARKED; 41 ... 50 (10x); not stretchable; Horizontal marking; snap-on type; white	www.wago.com/793-506/000-017
	Артикул №: 793-5501 WMB marking card; as card; for terminal block width 5 - 17.5 mm; stretchable 5 - 5.2 mm; plain; snap-on type; white	www.wago.com/793-5501

**Артикул №: 793-5501/000-002**

WMB marking card; as card; for terminal block width 5 - 17.5 mm; stretchable 5 - 5.2 mm; plain; snap-on type; yellow

www.wago.com/793-5501

/000-002

**Артикул №: 793-5501/000-005**

WMB marking card; as card; stretchable 5 - 5.2 mm; plain; snap-on type; red

www.wago.com/793-5501

/000-005

**Артикул №: 793-5501/000-006**

WMB marking card; as card; stretchable 5 - 5.2 mm; plain; snap-on type; blue

www.wago.com/793-5501

/000-006

**Артикул №: 793-5501/000-007**

WMB marking card; as card; stretchable 5 - 5.2 mm; plain; snap-on type; gray

www.wago.com/793-5501

/000-007

**Артикул №: 793-5501/000-012**

WMB marking card; as card; stretchable 5 - 5.2 mm; plain; snap-on type; orange

www.wago.com/793-5501

/000-012

**Артикул №: 793-5501/000-014**

WMB marking card; as card; stretchable 5 - 5.2 mm; plain; snap-on type; brown

www.wago.com/793-5501

/000-014

**Артикул №: 793-5501/000-017**

WMB marking card; as card; stretchable 5 - 5.2 mm; plain; snap-on type; light green

www.wago.com/793-5501

/000-017

**Артикул №: 793-5501/000-023**

WMB marking card; as card; stretchable 5 - 5.2 mm; plain; snap-on type; green

www.wago.com/793-5501

/000-023

**Артикул №: 793-5501/000-024**

WMB marking card; as card; stretchable 5 - 5.2 mm; plain; snap-on type; violet

www.wago.com/793-5501

/000-024

**Артикул №: 793-566**

WMB marking card; as card; MARKED; 1 ... 50 (2x); not stretchable; Horizontal marking; snap-on type; white

www.wago.com/793-566**Артикул №: 793-566/000-002**

WMB marking card; as card; MARKED; 1 ... 50 (2x); not stretchable; Horizontal marking; snap-on type; white

www.wago.com/793-566

/000-002

**Артикул №: 793-566/000-005**

WMB marking card; as card; MARKED; 1 ... 50 (2x); not stretchable; Horizontal marking; snap-on type; white

www.wago.com/793-566

/000-005

**Артикул №: 793-566/000-006**

WMB marking card; as card; MARKED; 1 ... 50 (2x); not stretchable; Horizontal marking; snap-on type; white

www.wago.com/793-566

/000-006

**Артикул №: 793-566/000-007**

WMB marking card; as card; MARKED; 1 ... 50 (2x); not stretchable; Horizontal marking; snap-on type; white

www.wago.com/793-566

/000-007

**Артикул №: 793-566/000-012**

WMB marking card; as card; MARKED; 1 ... 50 (2x); not stretchable; Horizontal marking; snap-on type; white

www.wago.com/793-566

/000-012



Артикул №: 793-566/000-017

WMB marking card; as card; MARKED; 1 ... 50 (2x); not stretchable; Horizontal marking; snap-on type; white

www.wago.com/793-566/000-017



Артикул №: 793-566/000-023

WMB marking card; as card; MARKED; 1 ... 50 (2x); not stretchable; Horizontal marking; snap-on type; white

www.wago.com/793-566/000-023



Артикул №: 793-566/000-024

WMB marking card; as card; MARKED; 1 ... 50 (2x); not stretchable; Horizontal marking; snap-on type; white

www.wago.com/793-566/000-024

Изтегляния

Documentation

Instruction Leaflet

Stecksocket, Relaismodule, Optokopplermodule
Eingangsnennspannung DC 24 V, Schaltstrom 0,1 A

pdf
2,4 MB

[Изтегляне](#)

Additional Information

Disposal; Electrical and electronic equipment, Packaging

V 1.0.0

pdf
265,8 kB

[Изтегляне](#)

CAD/CAE-Data

CAD data

3D Download 857-304

URL

[Изтегляне](#)

Step file 857-03xx Series

1.0
Jun 30, 2011

STP
299,3 kB

[Изтегляне](#)

EPLAN

EPLAN Data Portal 857-304

[Изтегляне](#)

WSCAD

WSCAD Universe 857-304

[Изтегляне](#)

Подлежащи на промяна.

WAGO Kontakttechnik GmbH & Co. KG
Hansastr. 27
32423 Minden
Phone: +49571 887-0 | Fax: +49571 887-169
Email: info.de@wago.com | Web: www.wago.com

Имате ли въпроси относно нашите продукти?
Винаги ще се радваме да получим вашето обаждане на +359 2 489 46 09.